



Product Description

- System Input Power: 25W
- High Efficacy: 125 lm/W
- Input Frequency: 50/60Hz
- Bluetooth Wireless controls w/SMART Dimming & Color tunable

BT Bluetooth System is an advanced tunable office lighting system that can provide daylight simulation between 2,700K to 6,500K, while dynamically interacting with both occupancy and photo sensors.



Wall Controller Option



Certification & Qualification



ORDERING INFORMATION

BT	22	-025	BT	CT	SUS-56
Model	Light Panel Size	Wattage	Control Option	CCT Color Tunable	Mounting
Beetle Troffer	2' x 2'	025 25 Watt	BT Bluetooth Wireless Control System	CT 2,700K ~ 6,500K	SUS-56 Samjin US Recessed

Product Specification

> **Bluetooth – Color Tuning**

Performance	BT22-025BTCTSUS-56
Luminous Flux(lm)	3,125 lm
Power Consumption	25W
Power factor	> 0.9
Efficacy(lm/W)	125 lm/W
CCT(K)	2700K~ 6500K
CRI(Ra)	> 80
Beam Angle(°)	110
Input Voltage(V)	100 - 277Vac
Operating Temp	-20°C~45°C
※ Tolerance Range : ± 10%	

Physical Info

Dimension	23.7" x 23.7" x 4.2"
Luminous active	22.1" x 7.1"
Weight	8.8 lbs.

Dimensions

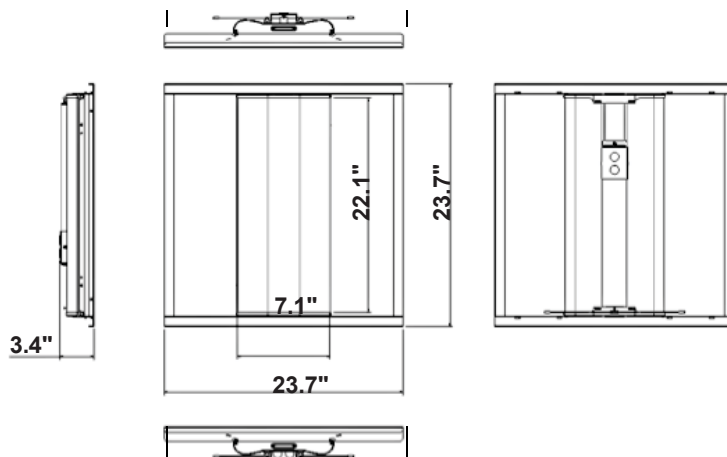

U.S. Sales Partner ~

Controlled Lighting Corp.

NY – 914-806-6684 ~ CA - 415-935-1346

sales@controlledlighting.net

SAMJIN LED Inc.

900 Lane Avenue, Suite 170, Chula Vista, CA 91914

lighting@samjinled.com

Rev. 05/01/2018

Specifications subject to change without notice.

LIGHT DISTRIBUTION & DISTANCE LUMINARY

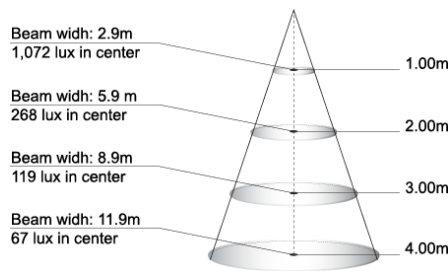
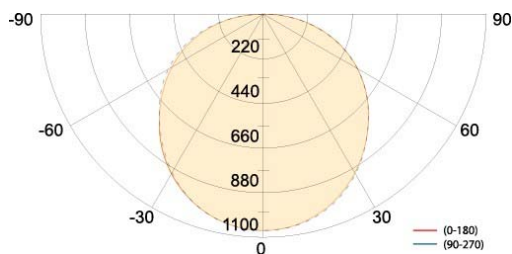

Average Beam Angle=110°

ZONAL LUMEN SUMMARY

Zone	Lumens	% Lamp	Luminaire
0~30	1,085	35	35
30~60	1,516	48	48
60~90	524	17	17
0~90	3,125	100	100

COEFFICIENTS OF UTILIZATION

RC	90				70				50			0
	60	50	30	10	60	50	30	10	50	30	10	0
R	1.09	1.09	1.09	1.09	1.07	1.07	1.07	1.07	1.04	1.04	1.04	0.99
(0)												
1	0.99	0.97	0.94	0.90	0.96	0.95	0.92	0.89	0.93	0.90	0.87	0.83
2	0.89	0.86	0.80	0.75	0.87	0.84	0.78	0.74	0.81	0.77	0.73	0.69
3	0.81	0.76	0.69	0.63	0.78	0.74	0.68	0.62	0.72	0.66	0.62	0.58
4	0.73	0.68	0.60	0.54	0.71	0.66	0.59	0.53	0.64	0.58	0.53	0.50
5	0.67	0.61	0.53	0.46	0.64	0.59	0.52	0.46	0.58	0.51	0.46	0.43
6	0.61	0.55	0.47	0.41	0.59	0.54	0.46	0.40	0.52	0.45	0.40	0.38
7	0.56	0.50	0.42	0.36	0.54	0.49	0.41	0.36	0.48	0.41	0.36	0.33
8	0.52	0.46	0.38	0.32	0.50	0.45	0.37	0.32	0.44	0.37	0.32	0.30
9	0.48	0.42	0.34	0.29	0.46	0.41	0.34	0.29	0.40	0.33	0.29	0.27
10	0.45	0.39	0.31	0.26	0.43	0.38	0.31	0.26	0.37	0.31	0.26	0.24

CR = Room Cavity Ratio
 RC = Effective Ceiling Cavity Reflectance
 RW = Wall Reflectance



Product Description

- System Input Power: 34W
- High Efficacy: 125 lm/W
- Input Frequency: 50/60Hz
- Bluetooth Wireless controls w/SMART Dimming & Color tunable

BT Bluetooth System is an advanced tunable office lighting system that can provide daylight simulation between 2,700K to 6,500K, while dynamically interacting with both occupancy and photo sensors.



Wall Controller Option



Certification & Qualification



ORDERING INFORMATION

BT	24	-034	BT	CT	SUS-56
Model	Light Panel Size	Wattage	Control Option	CCT Color Tunable	Mounting
Beetle Troffer	2' x 4'	-034 34 Watt	BT Bluetooth Wireless Control System	CT 2,700K ~ 6,500K	SUS-56 Samjin US Recessed

Product Specification

> Bluetooth – Color Tuning

Performance	BT24-034BTCTSUS-56
Luminous Flux(lm)	4,250 lm
Power Consumption	34W
Power factor	> 0.9
Efficacy(lm/W)	125 lm/W
CCT(K)	2700K~ 6500K
CRI(Ra)	> 80
Beam Angle(°)	110
Input Voltage(V)	100 - 277Vac
Operating Temp	-20°C~45°C
※ Tolerance Range : ± 10%	

Physical Info

Dimension	47.7" x 23.7" x 4.2"
Luminous active	46.9" x 7.1"
Weight	16.1 lbs.

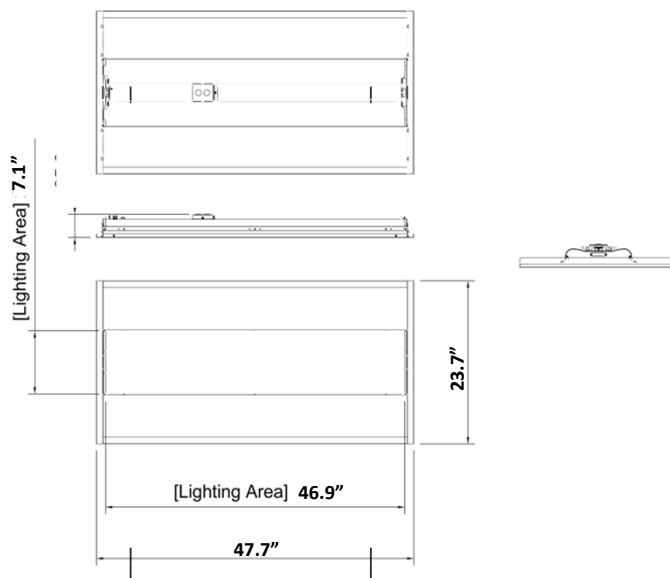

U.S. Sales Partner ~

Controlled Lighting Corp.

NY – 914-806-6684 ~ CA - 415-935-1346

sales@controlledlighting.net

SAMJIN LED Inc.

900 Lane Avenue, Suite 170, Chula Vista, CA 91914

lighting@samjinled.com

Rev. 05/01/2018

Specifications subject to change without notice.

LIGHT DISTRIBUTION & DISTANCE LUMINARY

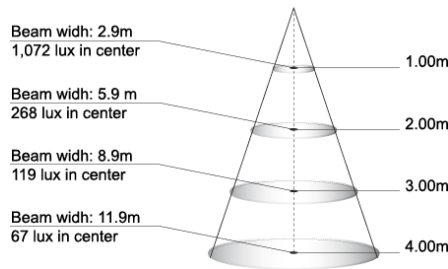
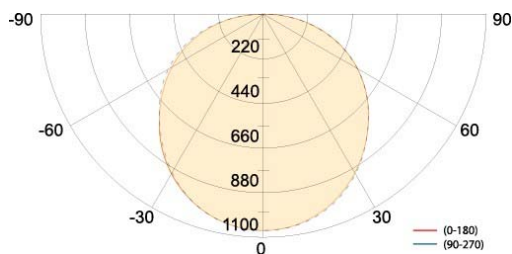

Average Beam Angle=110°

ZONAL LUMEN SUMMARY

Zone	Lumens	% Lamp	Luminaire
0~30	1,085	35	35
30~60	1,516	48	48
60~90	524	17	17
0~90	3,125	100	100

COEFFICIENTS OF UTILIZATION

RC	90				70				50			0
	60	50	30	10	60	50	30	10	50	30	10	0
R	1.09	1.09	1.09	1.09	1.07	1.07	1.07	1.07	1.04	1.04	1.04	0.99
(0)												
1	0.99	0.97	0.94	0.90	0.96	0.95	0.92	0.89	0.93	0.90	0.87	0.83
2	0.89	0.86	0.80	0.75	0.87	0.84	0.78	0.74	0.81	0.77	0.73	0.69
3	0.81	0.76	0.69	0.63	0.78	0.74	0.68	0.62	0.72	0.66	0.62	0.58
4	0.73	0.68	0.60	0.54	0.71	0.66	0.59	0.53	0.64	0.58	0.53	0.50
5	0.67	0.61	0.53	0.46	0.64	0.59	0.52	0.46	0.58	0.51	0.46	0.43
6	0.61	0.55	0.47	0.41	0.59	0.54	0.46	0.40	0.52	0.45	0.40	0.38
7	0.56	0.50	0.42	0.36	0.54	0.49	0.41	0.36	0.48	0.41	0.36	0.33
8	0.52	0.46	0.38	0.32	0.50	0.45	0.37	0.32	0.44	0.37	0.32	0.30
9	0.48	0.42	0.34	0.29	0.46	0.41	0.34	0.29	0.40	0.33	0.29	0.27
10	0.45	0.39	0.31	0.26	0.43	0.38	0.31	0.26	0.37	0.31	0.26	0.24

CR = Room Cavity Ratio
 RC = Effective Ceiling Cavity Reflectance
 RW = Wall Reflectance



Product Description

- System Input Power: 25W
- High Efficacy: 125 lm/W
- Input Frequency: 50/60Hz
- Bluetooth Wireless controls w/SMART Dimming & Color tunable

BT Bluetooth System is an advanced tunable office lighting system that can provide daylight simulation between 2,700K to 6,500K, while dynamically interacting with both occupancy and photo sensors.



Wall Controller Option



Certification & Qualification



ORDERING INFORMATION

BRK	22	-025	BT	CT	SUS-56
Model	Light Panel Size	Wattage	Control Option	CCT Color Tunable	Mounting
Retrofit Kit	2' x 2'	025 25 Watt	BT Bluetooth Wireless Control System	CT 2,700K ~ 6,500K	SUS-56 Samjin US Recessed

Product Specification

- RETROFIT KIT
- Bluetooth – Color Tuning

Performance	BRK22-025BTCTSUS-56
Luminous Flux(lm)	3,125 lm
Power Consumption	25 W
Power factor	> 0.9
Efficacy(lm/W)	125 lm/W
CCT(K)	2700K~ 6500K
CRI(Ra)	> 80
Beam Angle(°)	110
Input Voltage(V)	100 - 277Vac
Operating Temp	-20°C~45°C
※ Tolerance Range : ± 10%	

Physical Info

Dimension	22.5" x 21.4" x 2.7"
Luminous active	22.1" x 7.1"
Weight	5.5lbs.

Dimensions

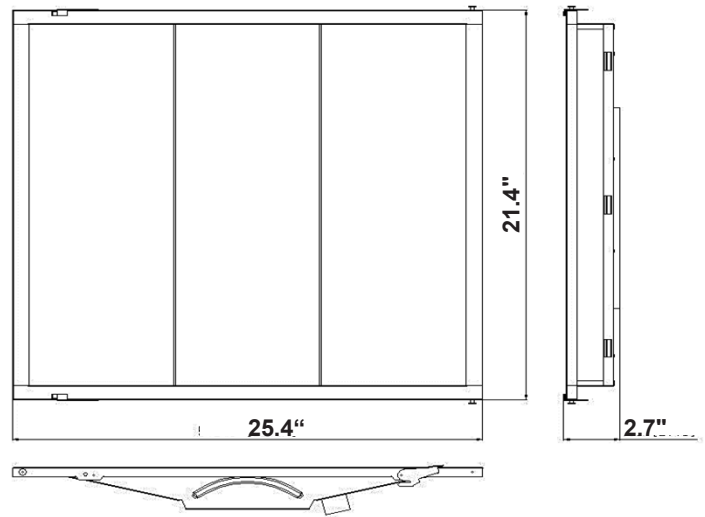

U.S. Sales Partner ~

Controlled Lighting Corp.

NY – 914-806-6684 ~ CA - 415-935-1346

sales@controlledlighting.net

SAMJIN LED Inc.

900 Lane Avenue, Suite 170, Chula Vista, CA 91914

lighting@samjinled.com

Rev. 05/01/2018

Specifications subject to change without notice.

LIGHT DISTRIBUTION & DISTANCE LUMINARY

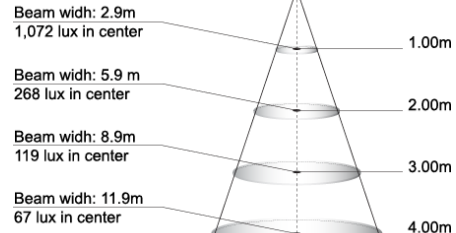
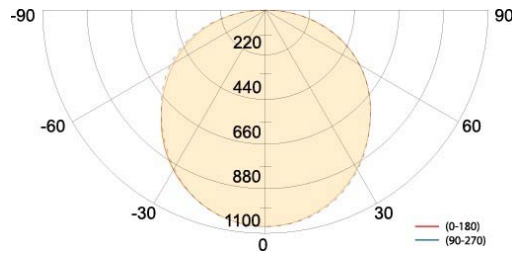

Average Beam Angle=110°

ZONAL LUMEN SUMMARY

Zone	Lumens	% Lamp	Luminaire
0~30	1,085	35	35
30~60	1,516	48	48
60~90	524	17	17
0~90	3,125	100	100

COEFFICIENTS OF UTILIZATION

RC	90				70				50			0
	60	50	30	10	60	50	30	10	50	30	10	0
R	1.09	1.09	1.09	1.09	1.07	1.07	1.07	1.07	1.04	1.04	1.04	0.99
(0)												
1	0.99	0.97	0.94	0.90	0.96	0.95	0.92	0.89	0.93	0.90	0.87	0.83
2	0.89	0.86	0.80	0.75	0.87	0.84	0.78	0.74	0.81	0.77	0.73	0.69
3	0.81	0.76	0.69	0.63	0.78	0.74	0.68	0.62	0.72	0.66	0.62	0.58
4	0.73	0.68	0.60	0.54	0.71	0.66	0.59	0.53	0.64	0.58	0.53	0.50
5	0.67	0.61	0.53	0.46	0.64	0.59	0.52	0.46	0.58	0.51	0.46	0.43
6	0.61	0.55	0.47	0.41	0.59	0.54	0.46	0.40	0.52	0.45	0.40	0.38
7	0.56	0.50	0.42	0.36	0.54	0.49	0.41	0.36	0.48	0.41	0.36	0.33
8	0.52	0.46	0.38	0.32	0.50	0.45	0.37	0.32	0.44	0.37	0.32	0.30
9	0.48	0.42	0.34	0.29	0.46	0.41	0.34	0.29	0.40	0.33	0.29	0.27
10	0.45	0.39	0.31	0.26	0.43	0.38	0.31	0.26	0.37	0.31	0.26	0.24

CR = Room Cavity Ratio
 RC = Effective Ceiling Cavity Reflectance
 RW = Wall Reflectance

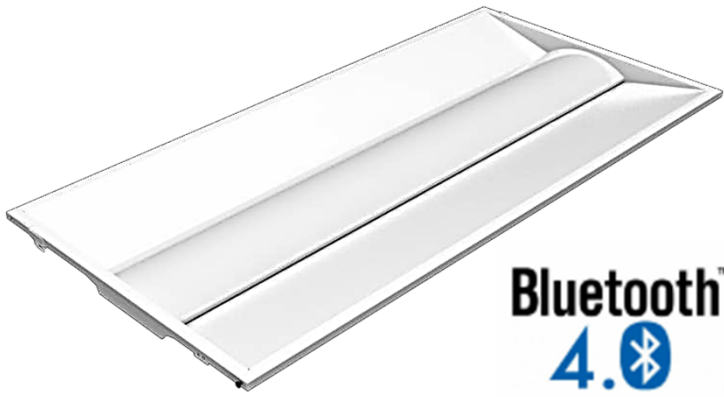

Product Description

- System Input Power: 34W
- High Efficacy: 125 lm/W
- Input Frequency: 50/60Hz
- Bluetooth Wireless controls w/SMART Dimming & Color tunable

BT Bluetooth System is an advanced tunable office lighting system that can provide daylight simulation between 2,700K to 6,500K, while dynamically interacting with both occupancy and photo sensors.



Wall Controller Option



Certification & Qualification



ORDERING INFORMATION

BRK	24	-034	BT	CT	SUS-56
Model	Light Panel Size	Wattage	Control Option	CCT Color Tunable	Mounting
Retrofit Kit	2' x 4'	-034 34 Watt	BT Bluetooth Wireless Control System	CT 2,700K ~ 6,500K	SUS-56 Samjin US Recessed

Product Specification

- RETROFIT KIT
- Bluetooth – Color Tuning

Performance	BRK24-034BTCTSUS-56
Luminous Flux(lm)	4,250 lm
Power Consumption	34W
Power factor	> 0.9
Efficacy(lm/W)	125 lm/W
CCT(K)	2700K~ 6500K
CRI(Ra)	> 80
Beam Angle(°)	110
Input Voltage(V)	100 - 277Vac
Operating Temp	-20°C~45°C
※ Tolerance Range : ± 10%	

Physical Info

Dimension	45.4" x 22.5" x 2.7"
Luminous active	46.9" x 7.1"
Weight	12.1 lbs.

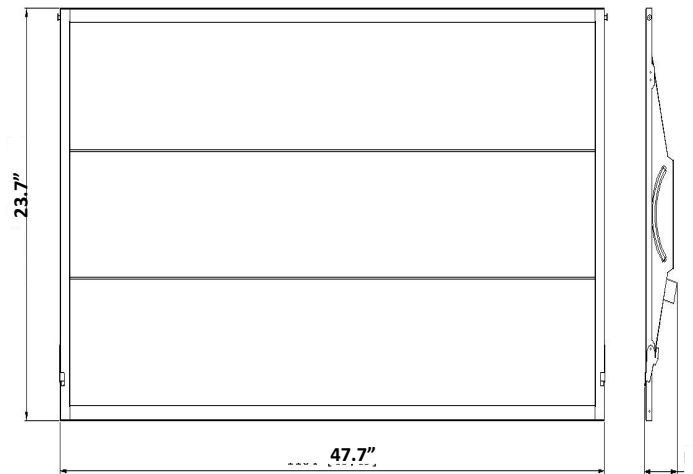

U.S. Sales Partner ~

Controlled Lighting Corp.

NY – 914-806-6684 ~ CA - 415-935-1346

sales@controlledlighting.net

SAMJIN LED Inc.

900 Lane Avenue, Suite 170, Chula Vista, CA 91914

lighting@samjinled.com

Rev. 05/01/2018

Specifications subject to change without notice.

LIGHT DISTRIBUTION & DISTANCE LUMINARY

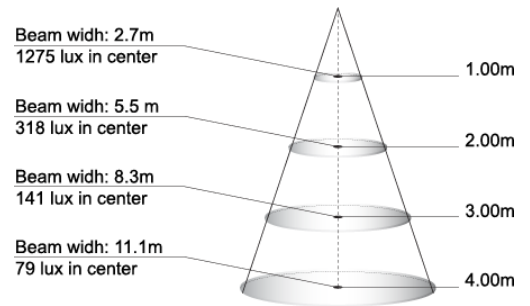
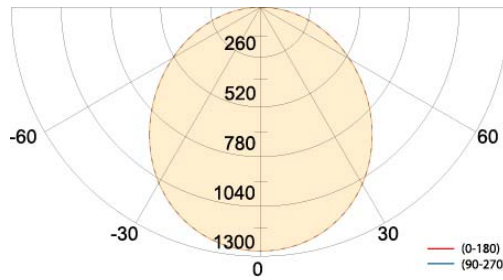

ZONAL LUMEN SUMMARY

Zone	Lumens	% Lamp	Luminaire
0~30	1,361	32	32
30~60	2,142	50	50
60~90	747	18	18
0~90	4,250	100	100

COEFFICIENTS OF UTILIZATION

RC	90				70				50			0
	60	50	30	10	60	50	30	10	50	30	10	0
RW	60	50	30	10	60	50	30	10	50	30	10	0
RCR (0)	1.09	1.09	1.09	1.09	1.07	1.07	1.07	1.07	1.04	1.04	1.04	0.99
1	0.99	0.97	0.94	0.90	0.96	0.95	0.92	0.89	0.93	0.90	0.87	0.83
2	0.89	0.86	0.80	0.75	0.87	0.84	0.78	0.74	0.81	0.77	0.73	0.69
3	0.81	0.76	0.69	0.63	0.78	0.74	0.68	0.62	0.72	0.66	0.62	0.58
4	0.73	0.68	0.60	0.54	0.71	0.66	0.59	0.53	0.64	0.58	0.53	0.50
5	0.67	0.61	0.53	0.46	0.64	0.59	0.52	0.46	0.58	0.51	0.46	0.43
6	0.61	0.55	0.47	0.41	0.59	0.54	0.46	0.40	0.52	0.45	0.40	0.38
7	0.56	0.50	0.42	0.36	0.54	0.49	0.41	0.36	0.48	0.41	0.36	0.33
8	0.52	0.46	0.38	0.32	0.50	0.45	0.37	0.32	0.44	0.37	0.32	0.30
9	0.48	0.42	0.34	0.29	0.46	0.41	0.34	0.29	0.40	0.33	0.29	0.27
10	0.45	0.39	0.31	0.26	0.43	0.38	0.31	0.26	0.37	0.31	0.26	0.24

CR = Room Cavity Ratio
 RC = Effective Ceiling Cavity Reflectance
 RW = Wall Reflectance

SAMJIN LED Luminaire With an integral Emergency Battery Kit

FEATURES

SAMJIN LED Center Basket Panel recessed troffer luminaire with an integral **Philips Bodine Emergency LED Driver (BSL17C)**

is configured with a 90-minute Battery Pack, compliant with the NFPA 101 Life Safety Code

Operation

When AC power fails, it immediately switches to the emergency mode, operating the LEDs for 90 minutes. When AC power restored the emergency driver automatically returns to normal mode.
Recharge Time: 24Hrs.
Warranty: 5 years

Emergency LED Driver (BSL17C) Performance Summary

Delivered Light Output: 1300 (PLUS) lumens
Input Voltage: 120-277VAC
Input Current: 60 [Hz]
Input Power: 3.0 W
Output Voltage: $V_o = 30\sim 80$ [VDC]
Output Current: $I_o = 200$ [mA] (Max)
Output Power: 7.0 W (Max)

Battery Sustainability Time

Illumination Time: 90 minute or more
Recharge Time: 24Hrs.
Test Switch: Indicator

Certification

UL 924 Issue:2006/02/24 Ed:9 Rev:2011/02/18
UL Standard for Safety Emergency Lighting and Power Equipment
CSA C22.2#141 Issue:2010/09/01 Ed:4 Unit Equipment for Emergency Lighting)



Ordering Information

Reference SAMJIN Troffer specsheets for ordering details.